

### Description

The LMAK15P10 uses advanced trench technology to provide excellent  $R_{DS(ON)}$ , low gate charge and operation with gate voltages as low as 4.5V. This device is suitable for use as a Battery protection or in other Switching application.

### General Features

$V_{DS} = -100V$   $I_D = -15A$

$R_{DS(ON)} < 185m\Omega$  @  $V_{GS}=10V$  (Type: 145m $\Omega$ )

### Application

Brushless motor

Load switch

Uninterruptible power supply

### Dimensions TO-252

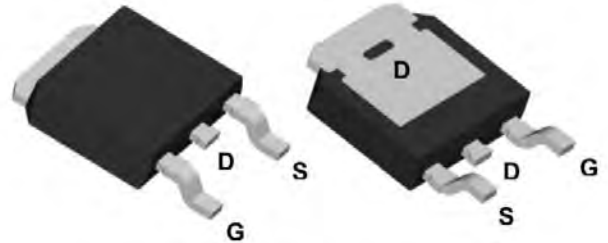

### Pin Configuration

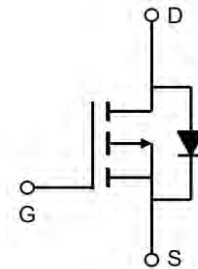

### Package Marking and Ordering Information

| Product ID | Pack   | Marking           | Qty(PCS) |
|------------|--------|-------------------|----------|
| LMAK15P10  | TO-252 | AP15P10D XXX YYYY | 2500     |

### Absolute Maximum Ratings ( $T_C=25^\circ C$ unless otherwise noted)

| Symbol                | Parameter  | Rating     | Units        |
|-----------------------|--|------------|--------------|
| $V_{DS}$              | Drain-Source Voltage                                   | -100       | V            |
| $V_{GS}$              | Gate-Source Voltage                                    | $\pm 20$   | V            |
| $I_D@T_C=25^\circ C$  | Continuous Drain Current, $V_{GS}$ @ -10V <sup>1</sup> | -15        | A            |
| $I_D@T_C=100^\circ C$ | Continuous Drain Current, $V_{GS}$ @ -10V <sup>1</sup> | -12        | A            |
| $I_{DM}$              | Pulsed Drain Current <sup>2</sup>                      | -45        | A            |
| EAS                   | Single Pulse Avalanche Energy <sup>3</sup>             | 56         | mJ           |
| $I_{AS}$              | Avalanche Current                                      | -15        | A            |
| $P_D@T_C=25^\circ C$  | Total Power Dissipation <sup>4</sup>                   | 50         | W            |
| $T_{STG}$             | Storage Temperature Range                              | -55 to 150 | $^\circ C$   |
| $T_J$                 | Operating Junction Temperature Range                   | -55 to 150 | $^\circ C$   |
| $R_{\theta JA}$       | Thermal Resistance Junction-Ambient <sup>1</sup>       | 62.5       | $^\circ C/W$ |
| $R_{\theta JC}$       | Thermal Resistance Junction-Case <sup>1</sup>          | 2.5        | $^\circ C/W$ |

## P-Channel Electrical Characteristics (T<sub>J</sub> =25 °C, unless otherwise noted)

| Symbol          | Parameter  | Test Condition  | Min. | Typ  | Max. | Units |
|-----------------|--|---|------|------|------|-------|
| BVDSS           | Drain-Source Breakdown Voltage                           | V <sub>GS</sub> = 0V, I <sub>D</sub> = -250μA   | -100 | -    | -    | V     |
| IDSS            | Zero Gate Voltage Drain Current                          | V <sub>DS</sub> = -80V, V <sub>GS</sub> = 0V  | -    | -    | 1    | μA    |
| IGSS            | Gate to Body Leakage Current                             | V <sub>DS</sub> = 0V, V <sub>GS</sub> = ±20V  | -    | -    | ±100 | nA    |
| VGS(th)         | Gate Threshold Voltage                                   | V <sub>DS</sub> = V <sub>GS</sub> , I <sub>D</sub> = -250μA   | -1.0 | -    | -2.5 | V     |
| RDS(on)         | Static Drain-Source On-Resistance <sup>note1</sup>       | V <sub>GS</sub> = -10V, I <sub>D</sub> = -2A  | -    | 145  | 185  | mΩ    |
|                 |  | V <sub>GS</sub> = -4.5V, I <sub>D</sub> = -1A   | -    | 170  | 200  |       |
| Ciss            | Input Capacitance  | V <sub>DS</sub> = -50V, V <sub>GS</sub> = 0V, f = 1.0MHz  | -    | 1545 | -    | pF    |
| Coss            | Output Capacitance                                       |   | -    | 37   | -    | pF    |
| Crss            | Reverse Transfer Capacitance                             |   | -    | 25   | -    | pF    |
| Q <sub>g</sub>  | Total Gate Charge  | V <sub>DD</sub> = -50V, I <sub>D</sub> = -2A, V <sub>GS</sub> = -10V  | -    | 27   | -    | nC    |
| Q <sub>gs</sub> | Gate-Source Charge                                       |   | -    | 5.3  | -    | nC    |
| Q <sub>gd</sub> | Gate-Drain("Miller") Charge                              |   | -    | 3.2  | -    | nC    |
| td(on)          | Turn-On Delay Time                                       | V <sub>DS</sub> = -50V, I <sub>D</sub> = -2A<br>R <sub>G</sub> =4.5Ω, R <sub>L</sub> =25Ω<br>V <sub>GEN</sub> = -10 V | -    | 10   | -    | ns    |
| t <sub>r</sub>  | Turn-On Rise Time  |   | -    | 27   | -    | ns    |
| td(off)         | Turn-Off Delay Time                                      |   | -    | 288  | -    | ns    |
| t <sub>f</sub>  | Turn-Off Fall Time                                       |   | -    | 88   | -    | ns    |
| IS              | Maximum Continuous Drain to Source Diode Forward Current |   | -    | -    | -18  | A     |
| VSD             | Drain to Source Diode Forward Voltage <sup>note1</sup>   | V <sub>GS</sub> = 0V, I <sub>S</sub> = -2A  | -    | -    | -1.3 | V     |
| t <sub>rr</sub> | Reverse Recovery Time                                    | V <sub>GS</sub> = 0V, I <sub>sd</sub> = -6A, di/dt = 100A/μs  | -    | 40   | -    | nS    |
| Q <sub>rr</sub> | Reverse Recovery Charge                                  |   | -    | 28   | -    | nC    |

Note :

- 1、 The data tested by surface mounted on a 1 inch 2 FR-4 board with 2OZ copper.
- 2、 The data tested by pulsed , pulse width ≅ 300us , duty cycle ≅ 2%
- 3、 The EAS data shows Max. rating . The test condition is V<sub>DD</sub> = -72V, V<sub>GS</sub> = -10V, L=0.1mH, I<sub>AS</sub> = -15A
- 4、 The power dissipation is limited by 150°C junction temperature
- 5、 The data is theoretically the same as I<sub>D</sub> and I<sub>DM</sub> , in real applications , should be limited by total power dissipation.

## Typical Characteristics

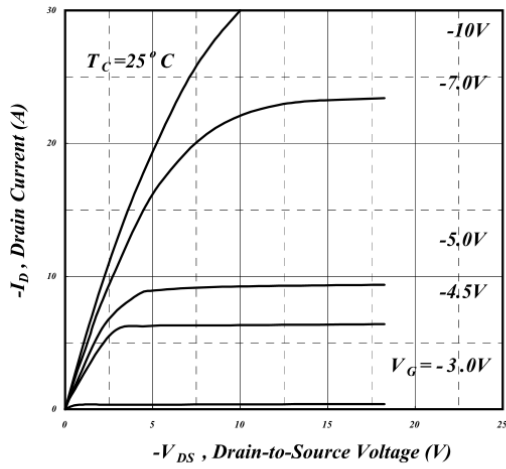

Fig 1. Typical Output Characteristics

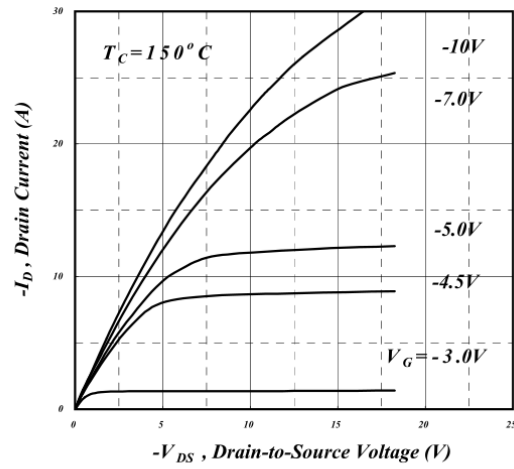

Fig 2. Typical Output Characteristics

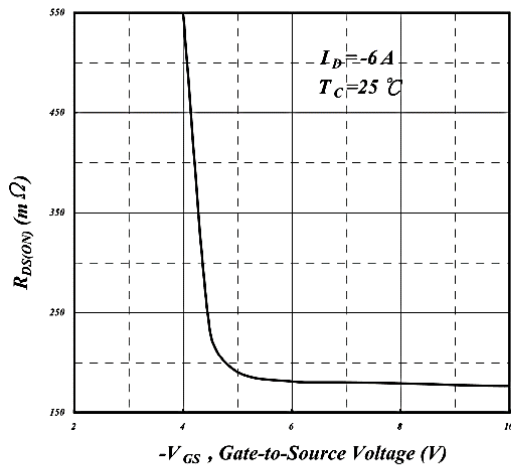

Fig 3. On-Resistance v.s. Gate Voltage

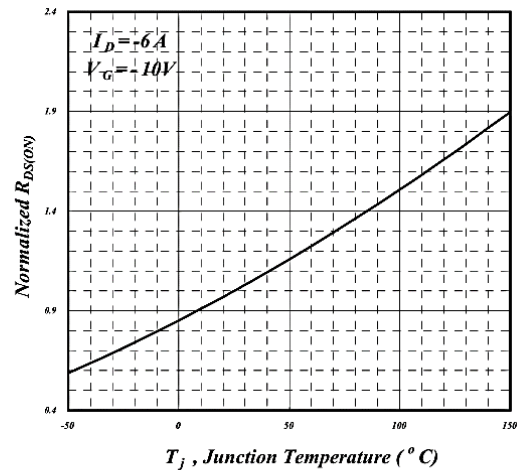

Fig 4. Normalized On-Resistance v.s. Junction Temperature

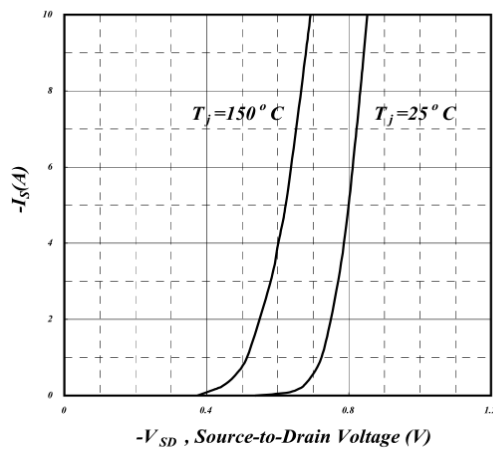

Fig 5. Forward Characteristic of Reverse Diode

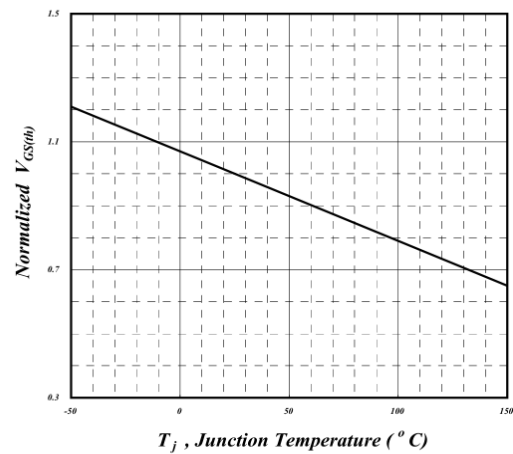

Fig 6. Gate Threshold Voltage v.s. Junction Temperature

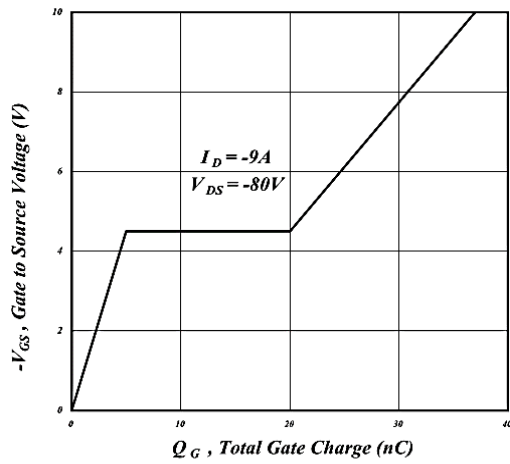

Fig 7. Gate Charge Characteristics

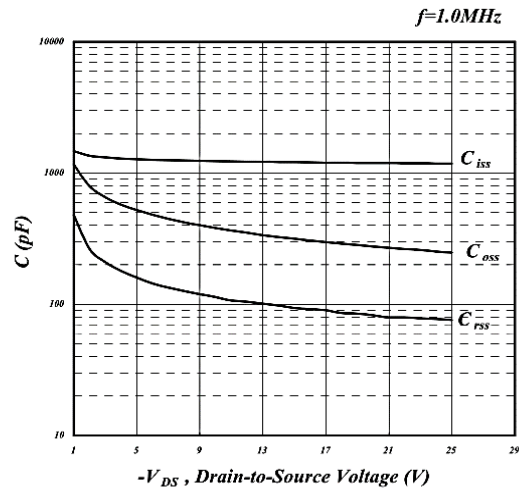

Fig 8. Typical Capacitance Characteristics

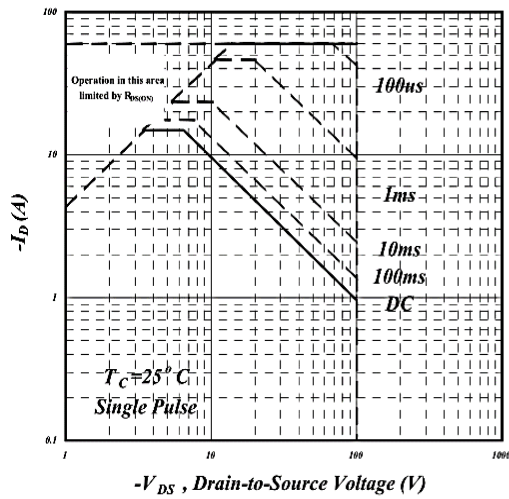

Fig 9. Maximum Safe Operating Area

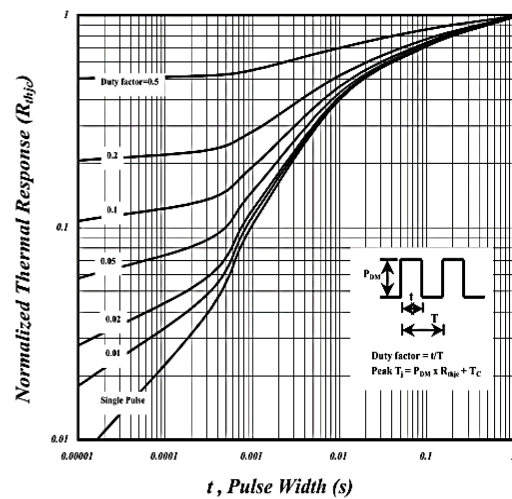

Fig 10. Effective Transient Thermal Impedance

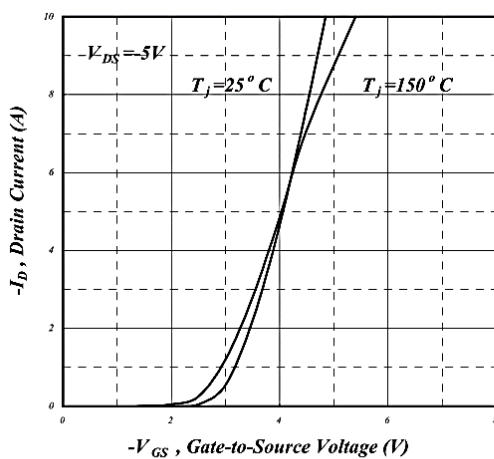

Fig 11. Transfer Characteristics

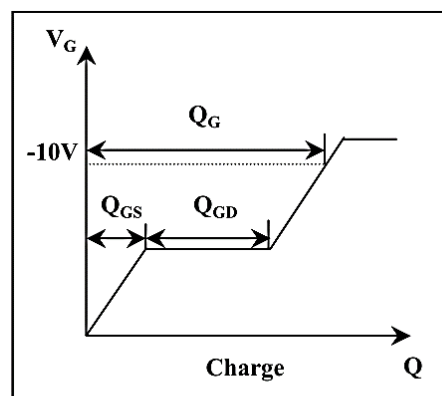
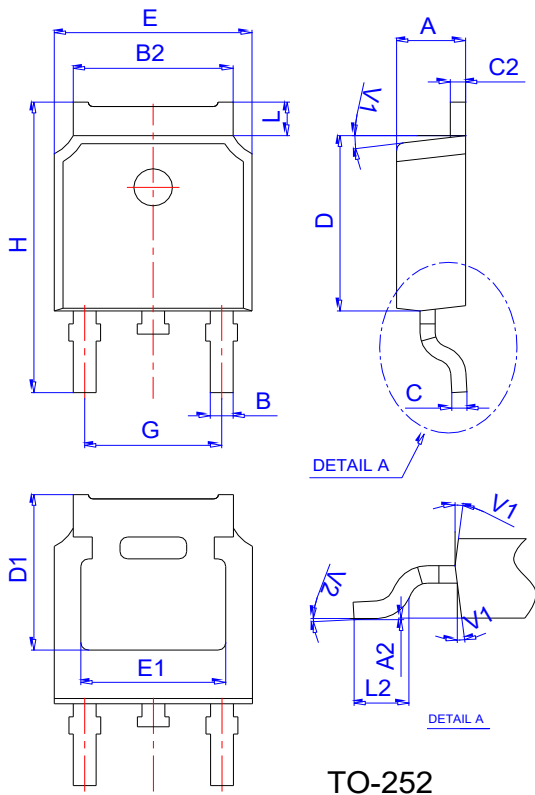

Fig 12. Gate Charge Waveform

## Package Mechanical Data:TO-252-3L



TO-252

| Ref. | Dimensions  |      |       |          |      |       |
|------|-------------|------|-------|----------|------|-------|
|      | Millimeters |      |       | Inches   |      |       |
|      | Min.        | Typ. | Max.  | Min.     | Typ. | Max.  |
| A    | 2.10        |      | 2.50  | 0.083    |      | 0.098 |
| A2   | 0           |      | 0.10  | 0        |      | 0.004 |
| B    | 0.66        |      | 0.86  | 0.026    |      | 0.034 |
| B2   | 5.18        |      | 5.48  | 0.202    |      | 0.216 |
| C    | 0.40        |      | 0.60  | 0.016    |      | 0.024 |
| C2   | 0.44        |      | 0.58  | 0.017    |      | 0.023 |
| D    | 5.90        |      | 6.30  | 0.232    |      | 0.248 |
| D1   | 5.30REF     |      |       | 0.209REF |      |       |
| E    | 6.40        |      | 6.80  | 0.252    |      | 0.268 |
| E1   | 4.63        |      |       | 0.182    |      |       |
| G    | 4.47        |      | 4.67  | 0.176    |      | 0.184 |
| H    | 9.50        |      | 10.70 | 0.374    |      | 0.421 |
| L    | 1.09        |      | 1.21  | 0.043    |      | 0.048 |
| L2   | 1.35        |      | 1.65  | 0.053    |      | 0.065 |
| V1   |             | 7°   |       |          | 7°   |       |
| V2   | 0°          |      | 6°    | 0°       |      | 6°    |

## Reel Specification-TO-252

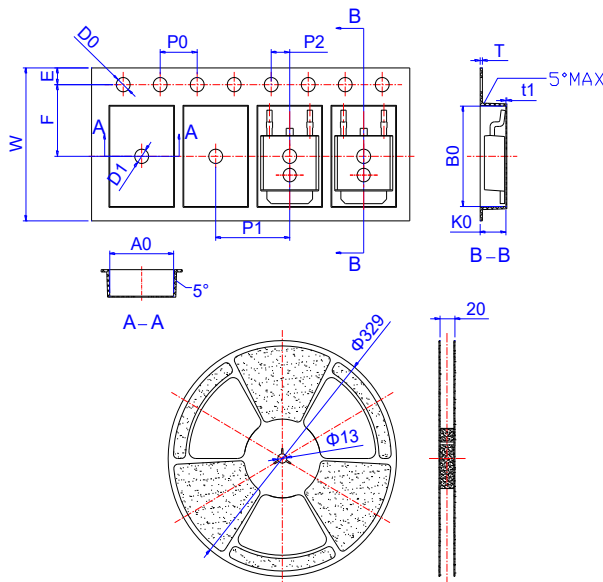

| Ref. | Dimensions  |       |       |        |       |       |
|------|-------------|-------|-------|--------|-------|-------|
|      | Millimeters |       |       | Inches |       |       |
|      | Min.        | Typ.  | Max.  | Min.   | Typ.  | Max.  |
| W    | 15.90       | 16.00 | 16.10 | 0.626  | 0.630 | 0.634 |
| E    | 1.65        | 1.75  | 1.85  | 0.065  | 0.069 | 0.073 |
| F    | 7.40        | 7.50  | 7.60  | 0.291  | 0.295 | 0.299 |
| D0   | 1.40        | 1.50  | 1.60  | 0.055  | 0.059 | 0.063 |
| D1   | 1.40        | 1.50  | 1.60  | 0.055  | 0.059 | 0.063 |
| P0   | 3.90        | 4.00  | 4.10  | 0.154  | 0.157 | 0.161 |
| P1   | 7.90        | 8.00  | 8.10  | 0.311  | 0.315 | 0.319 |
| P2   | 1.90        | 2.00  | 2.10  | 0.075  | 0.079 | 0.083 |
| A0   | 6.85        | 6.90  | 7.00  | 0.270  | 0.271 | 0.276 |
| B0   | 10.45       | 10.50 | 10.60 | 0.411  | 0.413 | 0.417 |
| K0   | 2.68        | 2.78  | 2.88  | 0.105  | 0.109 | 0.113 |
| T    | 0.24        |       | 0.27  | 0.009  |       | 0.011 |
| t1   | 0.10        |       |       | 0.004  |       |       |
| 10P0 | 39.80       | 40.00 | 40.20 | 1.567  | 1.575 | 1.583 |